

MIW3000 Series

5-6W, Wide Input Range DIP, Single & Dual Output DC/DC Converters

Key Features

- Efficiency up to 86%
- 1500VDC Isolation
- MTBF > 1,000,000 Hours
- 2:1 Wide Input Range
- UL 1950 Safety Approval
- Complies with EN55022 Class A
- Temperature Performance -40°C to $+71^{\circ}\text{C}$
- Industry Standard Pinout
- UL 94V-0 Package Material
- Internal SMD Construction



Minmax's MIW3000-Series Power modules are low-profile dc-dc converters that operate over input voltage ranges of 4.5-7VDC, 9-18VDC, 18-36VDC and 36-75VDC which provide precisely regulated output voltages of 3.3V, 5V, 12V, 15V, $\pm 5\text{V}$, $\pm 12\text{V}$ and $\pm 15\text{VDC}$.

The -40°C to $+71^{\circ}\text{C}$ operating temperature range makes it ideal for data communication equipments, mobile battery driven equipments, distributed power systems, telecommunication equipments, mixed analog/digital subsystems, process/machine control equipments, computer peripheral systems and industrial robot systems.

The modules have a maximum power rating of 6W and a typical full-load efficiency of 86%, continuous short circuit, 50mA output ripple, EN55022 Class A conducted noise compliance minimize design-in time, cost and eliminate the need for external filtering.

High Power Density
More Power

1500 VDC
I/O Isolation

EMI
EN55022

2:1
Wide Range

Block Diagram

Single Output

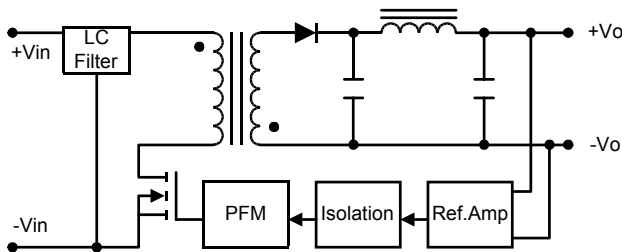

Dual Output

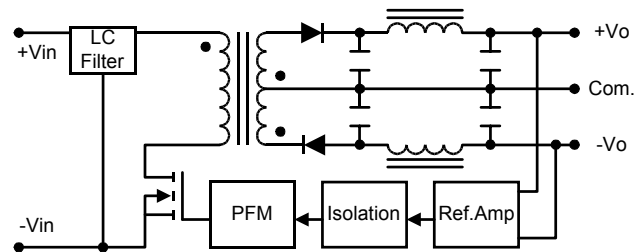

Model Selection Guide

| Model Number | Input Voltage | Output Voltage | Output Current | | Input Current | | Reflected Ripple Current | Efficiency |
|--------------|-----------------|-----------------|----------------|-------|---------------|-----------|--------------------------|------------|
| | | | Max. | Min. | @Max. Load | @No Load | | |
| | VDC | VDC | mA | mA | mA (Typ.) | mA (Typ.) | mA (Typ.) | % (Typ.) |
| MIW3011 | 5 (4.5 ~ 7) | 3.3 | 1200 | 60 | 1056 | 70 | 100 | 75 |
| MIW3012 | | 5 | 1000 | 50 | 1265 | | | 79 |
| MIW3013 | | 12 | 500 | 25 | 1463 | | | 82 |
| MIW3014 | | 15 | 400 | 20 | 1463 | | | 82 |
| MIW3015 | | ±5 | ±500 | ±25 | 1265 | | | 79 |
| MIW3016 | | ±12 | ±250 | ±12.5 | 1463 | | | 82 |
| MIW3017 | | ±15 | ±200 | ±10 | 1463 | | | 82 |
| MIW3021 | | 12 (9 ~ 18) | 3.3 | 1200 | 60 | | | 429 |
| MIW3022 | 5 | | 1000 | 50 | 514 | 81 | | |
| MIW3023 | 12 | | 500 | 25 | 595 | 84 | | |
| MIW3024 | 15 | | 400 | 20 | 595 | 84 | | |
| MIW3025 | ±5 | | ±500 | ±25 | 514 | 81 | | |
| MIW3026 | ±12 | | ±250 | ±12.5 | 595 | 84 | | |
| MIW3027 | ±15 | | ±200 | ±10 | 595 | 84 | | |
| MIW3031 | 24 (18 ~ 36) | | 3.3 | 1200 | 60 | 209 | 5 | 15 |
| MIW3032 | | 5 | 1000 | 50 | 251 | 83 | | |
| MIW3033 | | 12 | 500 | 25 | 291 | 86 | | |
| MIW3034 | | 15 | 400 | 20 | 291 | 86 | | |
| MIW3035 | | ±5 | ±500 | ±25 | 251 | 83 | | |
| MIW3036 | | ±12 | ±250 | ±12.5 | 291 | 86 | | |
| MIW3037 | | ±15 | ±200 | ±10 | 291 | 86 | | |
| MIW3041 | | 48 (36 ~ 75) | 3.3 | 1200 | 60 | 104 | | |
| MIW3042 | 5 | | 1000 | 50 | 126 | 83 | | |
| MIW3043 | 12 | | 500 | 25 | 145 | 86 | | |
| MIW3044 | 15 | | 400 | 20 | 145 | 86 | | |
| MIW3045 | ±5 | | ±500 | ±25 | 126 | 83 | | |
| MIW3046 | ±12 | | ±250 | ±12.5 | 145 | 86 | | |
| MIW3047 | ±15 | | ±200 | ±10 | 145 | 86 | | |

Absolute Maximum Ratings

| Parameter | Min. | Max. | Unit | |
|--|--------------------|-------|------|-----|
| Input Surge Voltage (1000 mS) | 5VDC Input Models | -0.7 | 10 | VDC |
| | 12VDC Input Models | -0.7 | 25 | VDC |
| | 24VDC Input Models | -0.7 | 50 | VDC |
| | 48VDC Input Models | -0.7 | 100 | VDC |
| Lead Temperature (1.5mm from case for 10 Sec.) | --- | 260 | °C | |
| Internal Power Dissipation | --- | 2,500 | mW | |

Exceeding the absolute maximum ratings of the unit could cause damage. These are not continuous operating ratings.

Environmental Specifications

| Parameter | Conditions | Min. | Max. | Unit |
|-----------------------|---------------------|------|------|------|
| Operating Temperature | Ambient | -40 | +71 | °C |
| Operating Temperature | Case | -40 | +90 | °C |
| Storage Temperature | | -40 | +125 | °C |
| Humidity | | --- | 95 | % |
| Cooling | Free-Air Convection | | | |
| Conducted EMI | EN55022 Class A | | | |

Notes :

- Specifications typical at Ta=+25°C, resistive load, nominal input voltage, rated output current unless otherwise noted.
- Transient recovery time is measured to within 1% error band for a step change in output load of 75% to 100%.
- Ripple & Noise measurement bandwidth is 0-20 MHz.
- These power converters require a minimum output loading to maintain specified regulation.
- Operation under no-load conditions will not damage these modules; however, they may not meet all specifications listed.
- All DC/DC converters should be externally fused at the front end for protection.
- Other input and output voltage may be available, please contact factory.
- Specifications subject to change without notice.

Input Specifications

| Parameter | Model | Min. | Typ. | Max. | Unit |
|--------------------------------|------------------|------|------|------|------|
| Start Voltage | 5V Input Models | 3 | 3.5 | 4.4 | VDC |
| | 12V Input Models | 4.5 | 6 | 8 | |
| | 24V Input Models | 8 | 12 | 16 | |
| | 48V Input Models | 16 | 24 | 32 | |
| Under Voltage Shutdown | 5V Input Models | --- | --- | 4 | |
| | 12V Input Models | --- | --- | 8 | |
| | 24V Input Models | --- | --- | 16 | |
| | 48V Input Models | --- | --- | 32 | |
| Reverse Polarity Input Current | All Models | --- | --- | 1 | A |
| Short Circuit Input Power | All Models | --- | 1000 | 3000 | mW |
| Input Filter | Pi Filter | | | | |

Output Specifications

| Parameter | Conditions | Min. | Typ. | Max. | Unit |
|------------------------------|--------------------------------|------|------------|------------|---------------|
| Output Voltage Accuracy | | --- | ± 0.5 | ± 1.0 | % |
| Output Voltage Balance | Dual Output, Balanced Loads | --- | ± 0.5 | ± 2.0 | % |
| Line Regulation | $V_{in} = \text{Min. to Max.}$ | --- | ± 0.1 | ± 0.3 | % |
| Load Regulation | $I_o = 20\% \text{ to } 100\%$ | --- | ± 0.3 | ± 1.0 | % |
| Ripple & Noise (20MHz) | | --- | 50 | 75 | mV P-P |
| Ripple & Noise (20MHz) | Over Line, Load & Temp. | --- | --- | 100 | mV P-P |
| Ripple & Noise (20MHz) | | --- | --- | 15 | mV rms |
| Over Power Protection | | 120 | --- | --- | % |
| Transient Recovery Time | 25% Load Step Change | --- | 150 | 300 | μs |
| Transient Response Deviation | | --- | ± 2 | ± 6 | % |
| Temperature Coefficient | | --- | ± 0.01 | ± 0.02 | %/°C |
| Output Short Circuit | Continuous | | | | |

General Specifications

| Parameter | Conditions | Min. | Typ. | Max. | Unit |
|-------------------------|-------------------------------------|-------|------|------|------------|
| Isolation Voltage Rated | 60 Seconds | 1500 | --- | --- | VDC |
| Isolation Voltage Test | Flash Tested for 1 Second | 1650 | --- | --- | VDC |
| Isolation Resistance | 500VDC | 1000 | --- | --- | M Ω |
| Isolation Capacitance | 100KHz, 1V | --- | 380 | 500 | pF |
| Switching Frequency | | --- | 300 | --- | KHz |
| MTBF | MIL-HDBK-217F @ 25°C, Ground Benign | 1,000 | --- | --- | K Hours |

Capacitive Load

| Models by Vout | 3.3V | 5V | 12V | 15V | $\pm 5V$ # | $\pm 12V$ # | $\pm 15V$ # | Unit |
|-------------------------|------|------|------|------|------------|-------------|-------------|---------------|
| Maximum Capacitive Load | 6800 | 6800 | 6800 | 6800 | 1000 | 1000 | 1000 | μF |

For each output

Input Fuse Selection Guide

| 5V Input Models | 12V Input Models | 24V Input Models | 48V Input Models |
|-------------------------|-------------------------|------------------------|------------------------|
| 3000mA Slow – Blow Type | 1500mA Slow – Blow Type | 700mA Slow – Blow Type | 350mA Slow – Blow Type |

Input Voltage Transient Rating

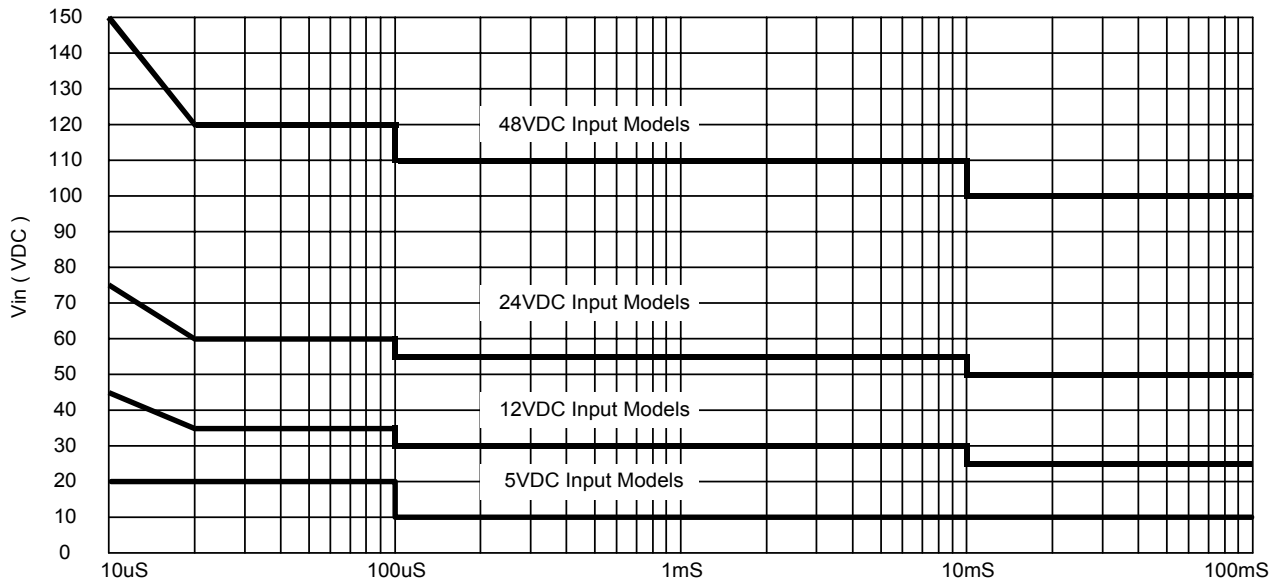

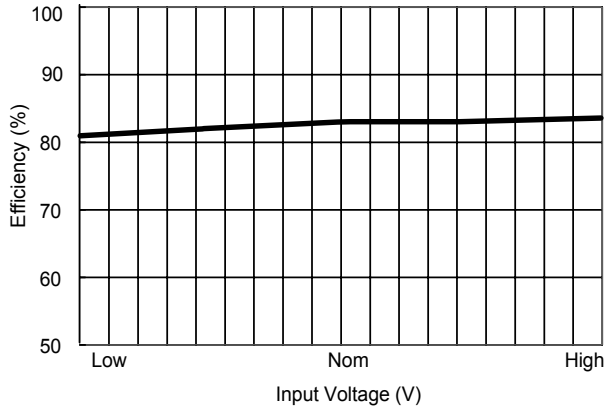

Efficiency vs Input Voltage (Single Output)

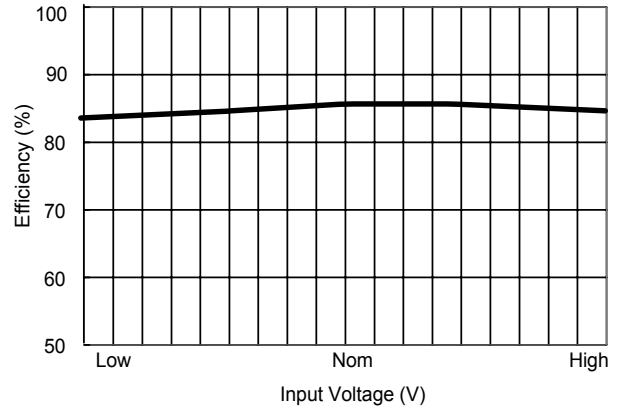

Efficiency vs Input Voltage (Dual Output)

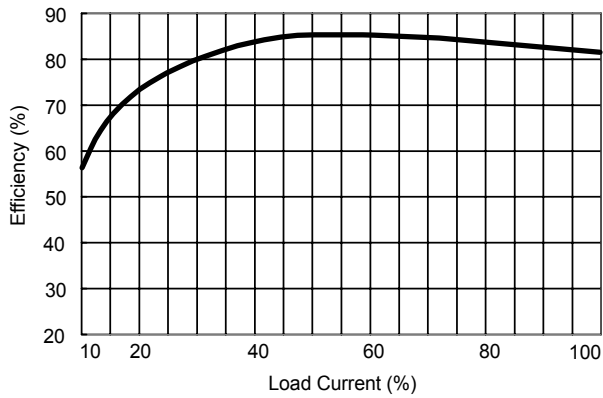

Efficiency vs Output Load (Single Output)

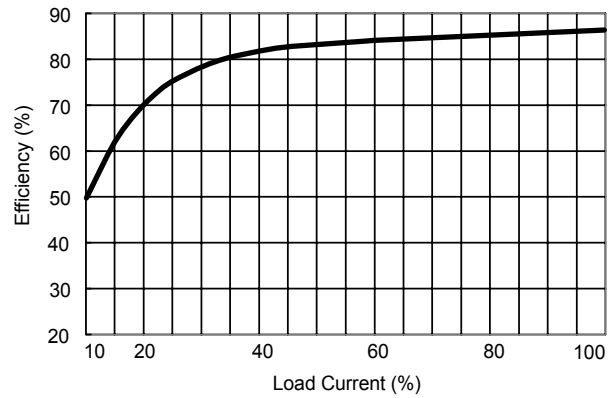

Efficiency vs Output Load (Dual Output)

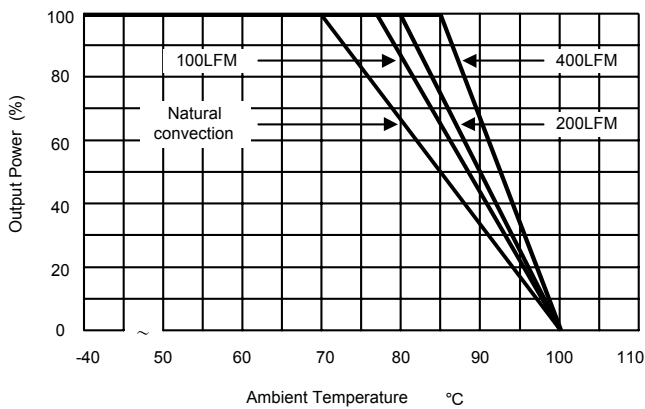

Derating Curve

Test Configurations

Input Reflected-Ripple Current Test Setup

Input reflected-ripple current is measured with an inductor L_{in} (4.7uH) and C_{in} (220uF, ESR < 1.0Ω at 100 KHz) to simulate source impedance.

Capacitor C_{in} , offsets possible battery impedance.

Current ripple is measured at the input terminals of the module, measurement bandwidth is 0–500 KHz.

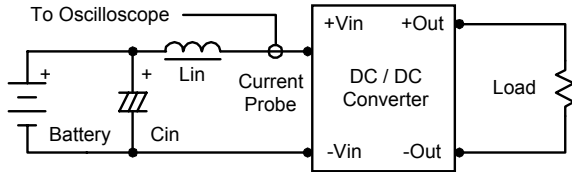

Peak-to-Peak Output Noise Measurement Test

Use a C_{out} 0.47uF ceramic capacitor.

Scope measurement should be made by using a BNC socket, measurement bandwidth is 0–20 MHz. Position the load between 50 mm and 75 mm from the DC/DC Converter.

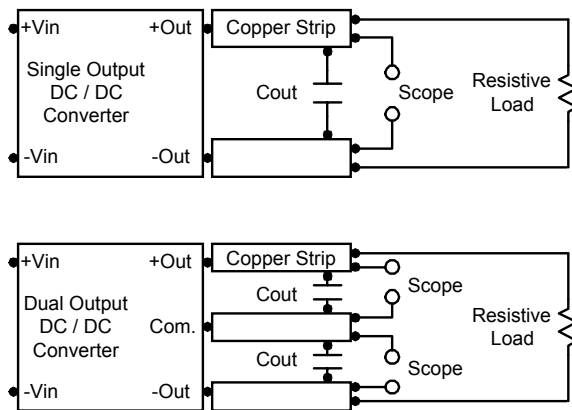

Design & Feature Considerations

Maximum Capacitive Load

The MIW3000 series has limitation of maximum connected capacitance at the output.

The power module may be operated in current limiting mode during start-up, affecting the ramp-up and the startup time.

For optimum performance we recommend 1000uF maximum capacitive load for dual outputs and 6800uF capacitive load for single outputs.

The maximum capacitance can be found in the data sheet.

Overcurrent Protection

To provide protection in a fault (output overload) condition, the unit is equipped with internal current limiting circuitry and can endure current limiting for an unlimited duration. At the point of current-limit inception, the unit shifts from voltage control to current control. The unit operates normally once the output current is brought back into its specified range.

Input Source Impedance

The power module should be connected to a low ac-impedance input source. Highly inductive source impedances can affect the stability of the power module.

In applications where power is supplied over long lines and output loading is high, it may be necessary to use a capacitor at the input to ensure startup.

Capacitor mounted close to the power module helps ensure stability of the unit, it is recommended to use a good quality low Equivalent Series Resistance (ESR < 1.0Ω at 100 KHz) capacitor of a 10uF for the 5V input devices, a 3.3uF for the 12V input devices and a 2.2uF for the 24V and 48V devices.

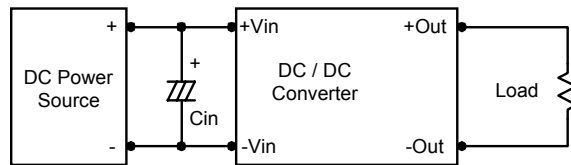

Output Ripple Reduction

A good quality low ESR capacitor placed as close as practicable across the load will give the best ripple and noise performance.

To reduce output ripple, it is recommended to use 3.3uF capacitors at the output.

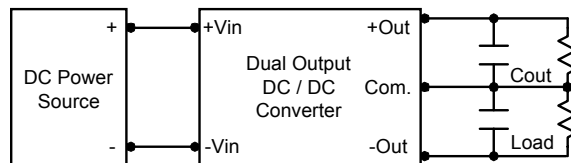
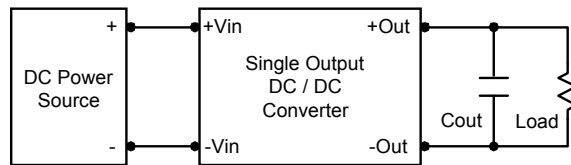

Thermal Considerations

Many conditions affect the thermal performance of the power module, such as orientation, airflow over the module and board spacing. To avoid exceeding the maximum temperature rating of the components inside the power module, the case temperature must be kept below 90°C.

The derating curves are determined from measurements obtained in an experimental apparatus.

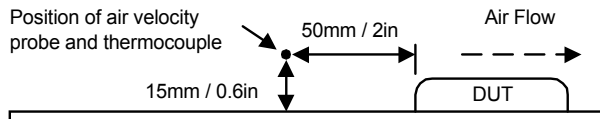

Mechanical Dimensions

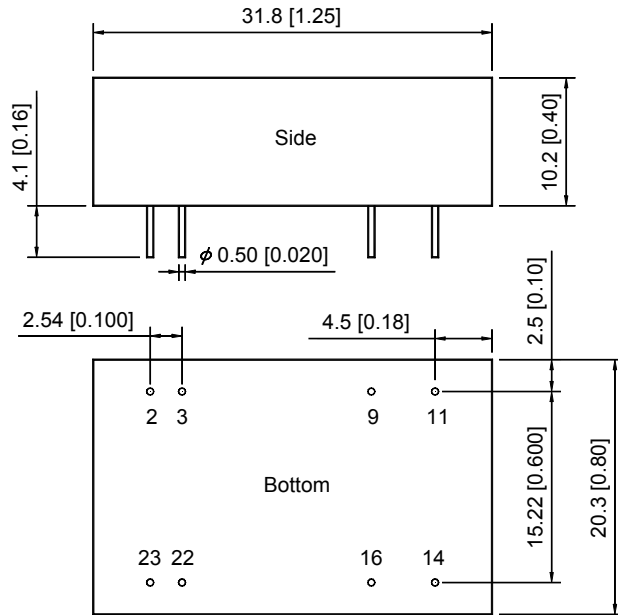

| Tolerance | Millimeters | Inches |
|-----------|-------------|-------------|
| | X.X±0.25 | X.XX±0.01 |
| | X.XX±0.13 | X.XXX±0.005 |
| Pin | ±0.05 | ±0.002 |

Connecting Pin Patterns

Top View (2.54 mm / 0.1 inch grids)

Single Output

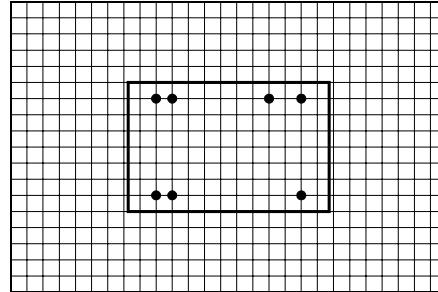

Dual Output

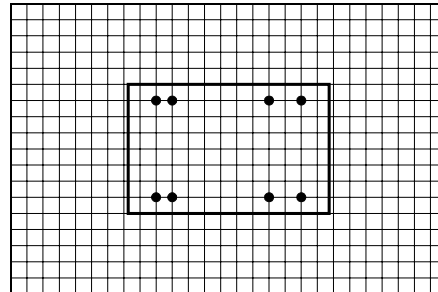

Pin Connections

| Pin | Single Output | Dual Output |
|-----|---------------|-------------|
| 2 | -Vin | -Vin |
| 3 | -Vin | -Vin |
| 9 | No Pin | Common |
| 11 | NC | -Vout |
| 14 | +Vout | +Vout |
| 16 | -Vout | Common |
| 22 | +Vin | +Vin |
| 23 | +Vin | +Vin |

NC: No Connection

Physical Characteristics

Case Size : 31.8×20.3×10.2 mm
1.25×0.80×0.40 inches

Case Material : Metal With Non-Conductive Baseplate

Weight : 16.9g

Flammability : UL94V-0

The MIW3000 converter is encapsulated in a low thermal resistance molding compound that has excellent resistance/electrical characteristics over a wide temperature range or in high humidity environments. The encapsulant and unit case are both rated to UL 94V-0 flammability specifications. Leads are tin plated for improved solderability.